

Contents

PVC-U Door Panels

Acacia	Page 2
Alnwick	Page 2
Althorpe	Page 3
Athens	Page 3
Balmoral	Page 4
Berlin	Page 5
Blenheim	Page 5
Bruges	Page 6
Cambridge	Page 6
Canterbury	Page 7
Canton	Page 7
Chatsworth	Page 8
Frankfurt	Page 8
Hamburg	Page 9
Harewood	Page 9
Highgrove	Page 10
Kensington	Page 10
Lyon	Page 11
Madrid	Page 11
Malaga	Page 12
Milan	Page 12
Modern	Page 13 - 14
Munich	Page 14
Oval	Page 15
Oxford	Page 15
Reims	Page 16
Richmond	Page 16
Rockingham	Page 17
Rome	Page 17
Sandringham	Page 18
Seville	Page 18
Sofia	Page 19
Turin	Page 19
Versailles	Page 20
Vienna	Page 20
Windsor	Page 21

Quarter Panels	Page 21
Conservatory Panels	Page 22 - 23
Half Panels	Page 23
Flat Panels	Page 24

MDF and Thickness Options	Page 24
Ancillaries	Page 25
Backing Glass Options	Page 25
Colour/Woodgrain Options	Page 26
Profile Options	Page 26
Stock Backing Glass	Page 27
Glass Sizes	Page 28
Notes	Page 29
Terms & Conditions	Page 30

Acacia Door Panels

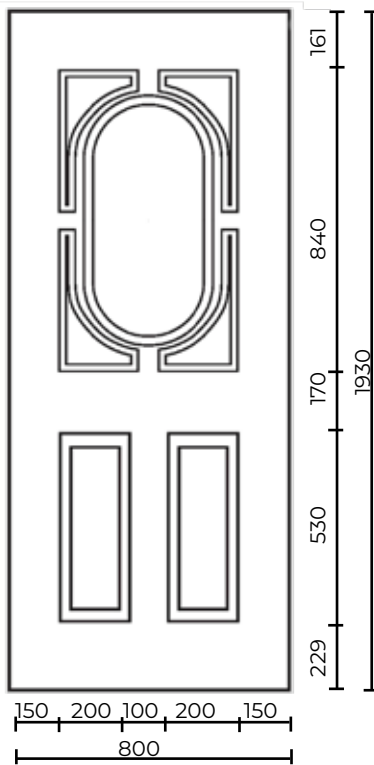

Minimum Cut Size
550mm x 1590mm

Acacia Solid Inverted
Acacia One Inverted

Alnwick Door Panels

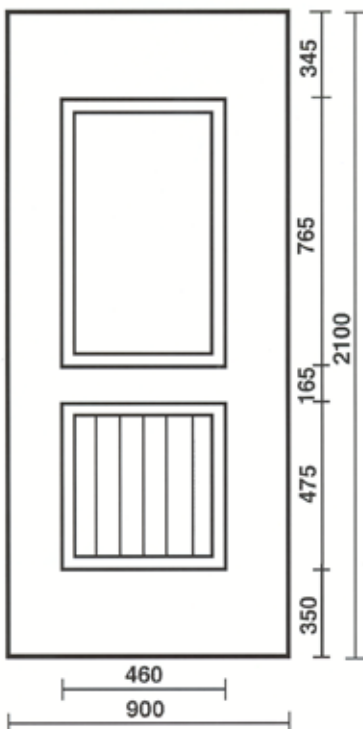

Minimum Cut Size
510mm x 1455mm

Alnwick Solid
Alnwick One
Alnwick One Inverted

Please Note - Not available with solid MDF reinforcing

Althorpe Door Panels

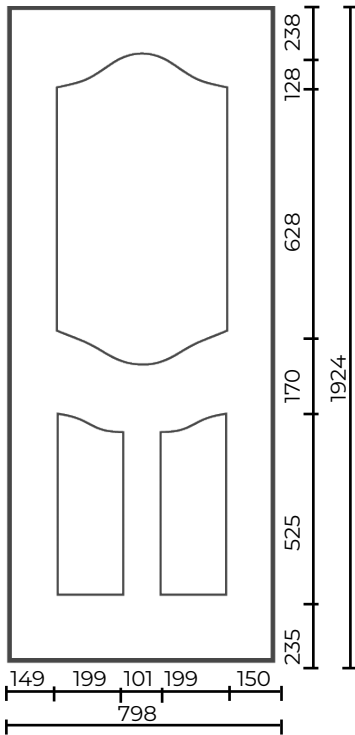

Minimum Cut Size
550mm x 1510mm

Althorpe Solid Oval Inverted
Althorpe One Inverted
Althorpe One Oval Inverted

Please Note - Not available with solid MDF reinforcing

Athens Door Panels

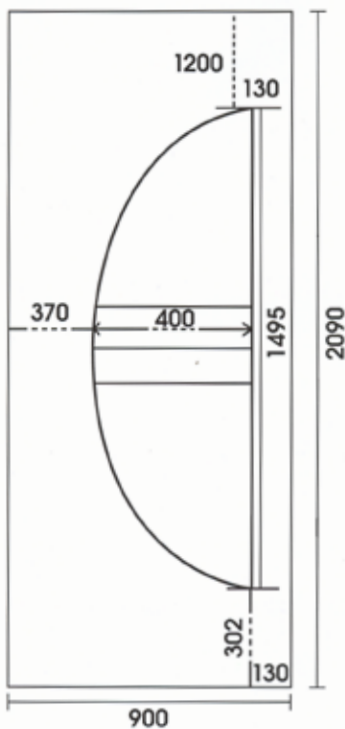

Minimum Cut Size
500mm x 1595mm

Athens Solid
Athens Two

Please note - Glass made up of 2 units

Balmoral Door Panels

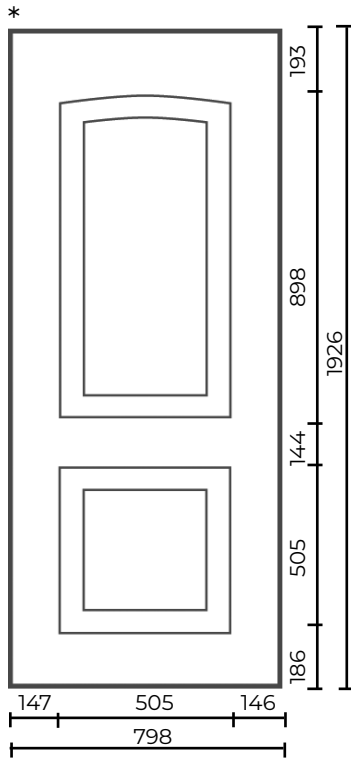

Small Aperture

Minimum Cut Size
550mm x 1595mm

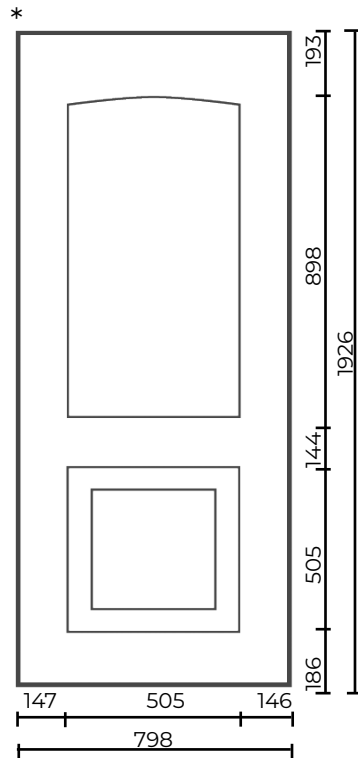

Large Aperture
(Classic)

Minimum Cut Size
550mm x 1595mm

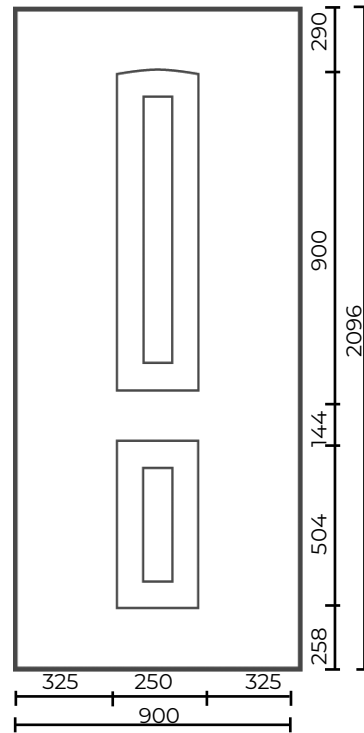

Side

Minimum Cut Size
300mm x 1595mm

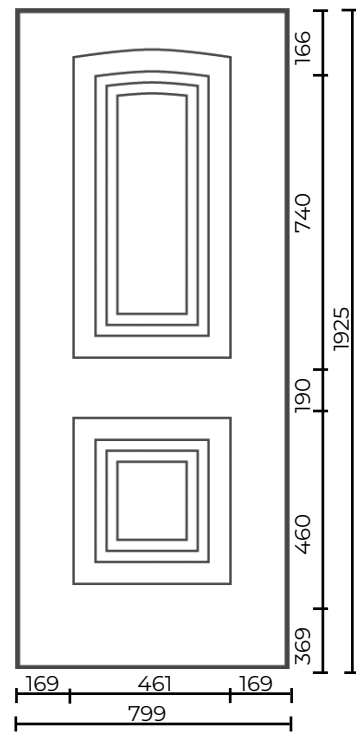

Slimline (Wenland)

Minimum Cut Size
510mm x 1435mm

*Available in Euro Size (900 x 2100)

Balmoral Solid
Balmoral One Small
Balmoral One Classic
Balmoral Two
Balmoral Two Classic
Balmoral One Slimline
Balmoral Two Slimline
Balmoral Side Solid
Balmoral One Classic Side
Balmoral Two Classic Side

Berlin Door Panels

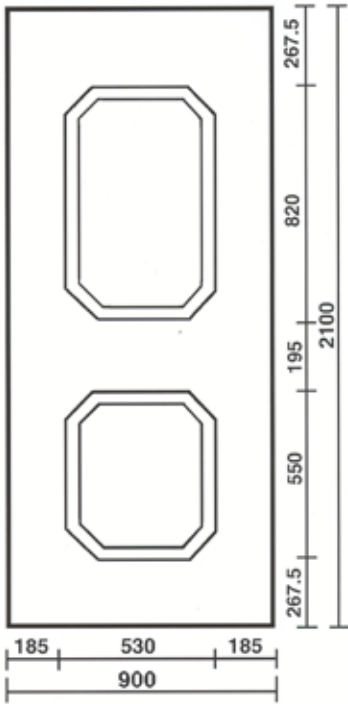

Minimum Cut Size
580mm x 1615mm

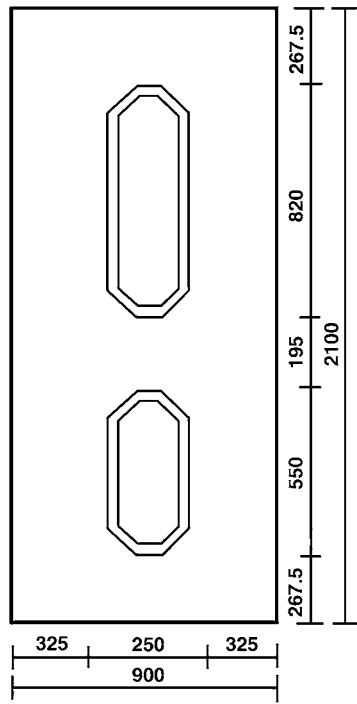

Minimum Cut Size
300mm x 1615mm

Berlin Solid
Berlin One
Berlin Solid Side
Berlin One Side

Blenheim Door Panels

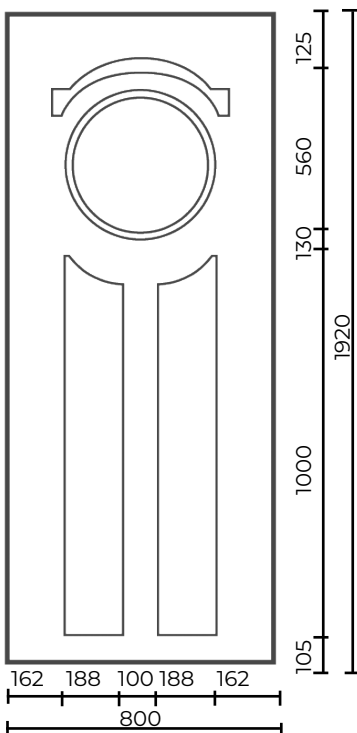

Minimum Cut Size
526mm x 1740mm

Blenheim Solid
Blenheim One

Bruges Door Panels

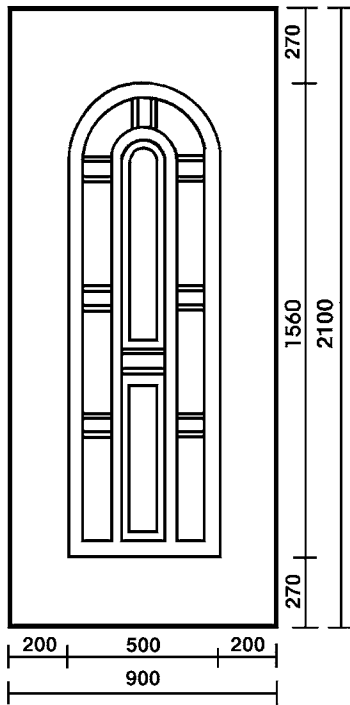

Minimum Cut Size
550mm x 1610mm

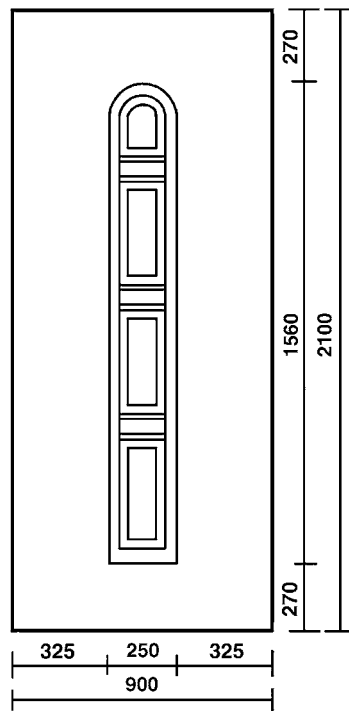

Minimum Cut Size
300mm x 1610mm

Bruges Solid
Bruges Two
Bruges Eight
Bruges Solid Side
Bruges One Side
Bruges Four Side

Cambridge Door Panels

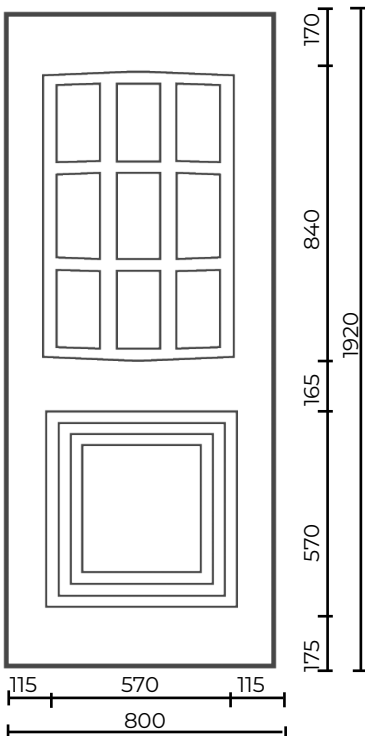

Minimum Cut Size
620mm x 1625mm

Cambridge Georgian Bow Fronted

Please note - One sealed glass unit, not individual pieces
Each rectangle is 110mm x 200mm
Projection - 33mm

Canterbury Door Panels

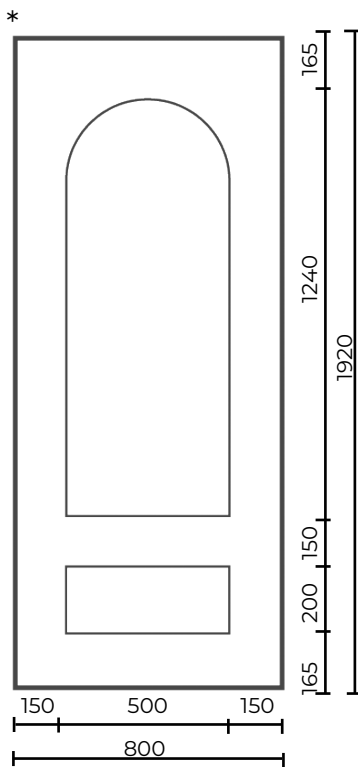

Minimum Cut Size
550mm x 1640mm

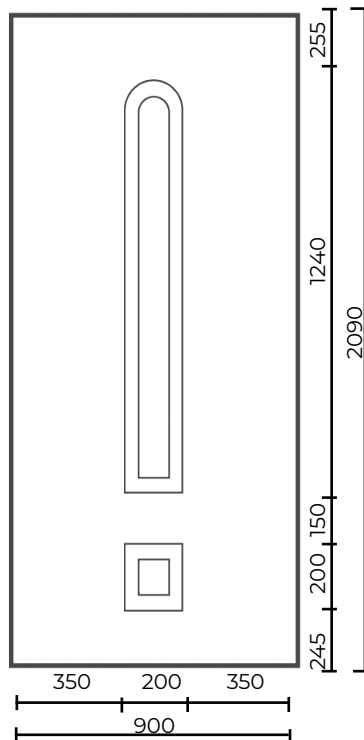

Minimum Cut Size
250mm x 1640mm

Canterbury Solid
Canterbury One
Canterbury Solid Side
Canterbury One Side

*Available in Euro Size (900 x 2100)

Please note - This panel must be reinforced

Canton Door Panels

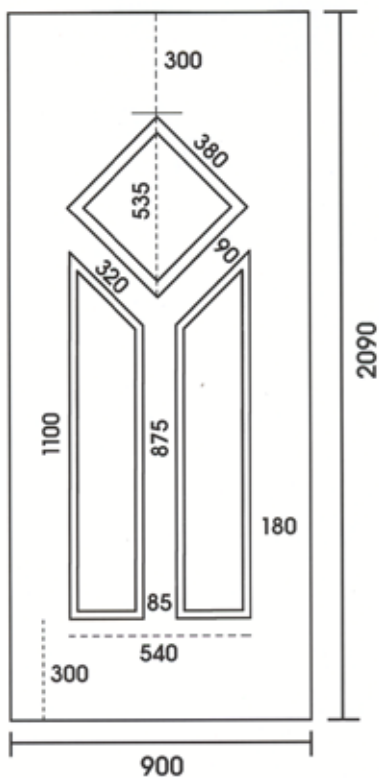

Minimum Cut Size
590mm x 1685mm

Canton Solid
Canton One

Chatsworth Door Panels

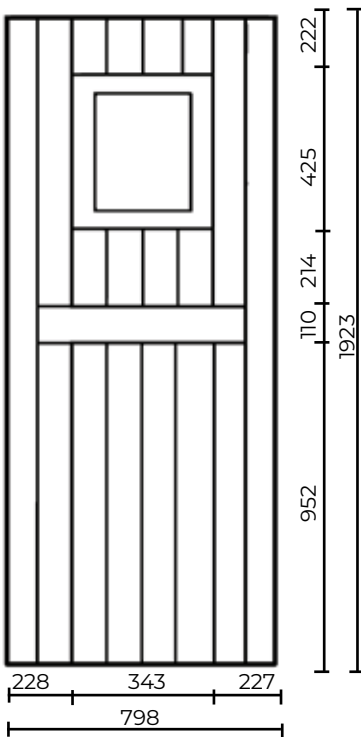

Minimum Cut Size
395mm x 805mm

Chatsworth Solid
Chatsworth One

Please Note - This panel is not available with solid MDF reinforcing

Frankfurt Door Panels

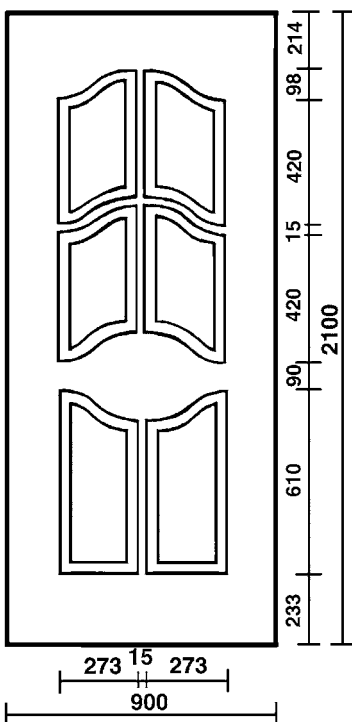

Minimum Cut Size
611mm x 1703mm

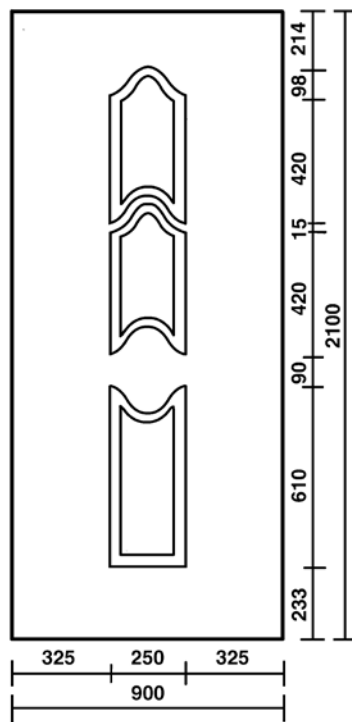

Minimum Cut Size
300mm x 1703

Frankfurt Solid
Frankfurt One
Frankfurt Solid Side
Frankfurt One Side

Hamburg Door Panels

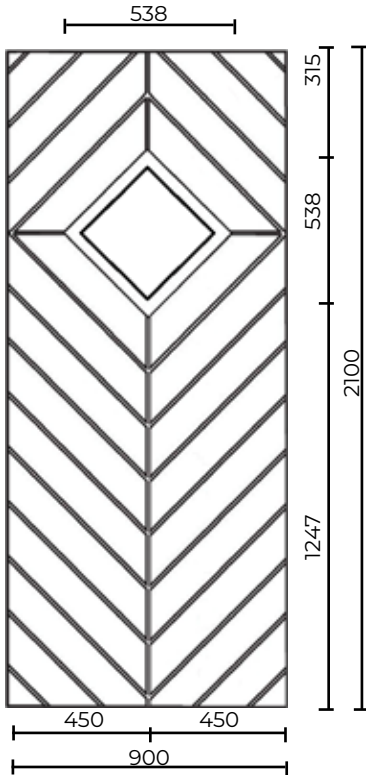

Minimum Cut Size
590mm x 590mm

Hamburg Solid
Hamburg One

Please Note - Not available with solid MDF reinforcing

Harewood Door Panels

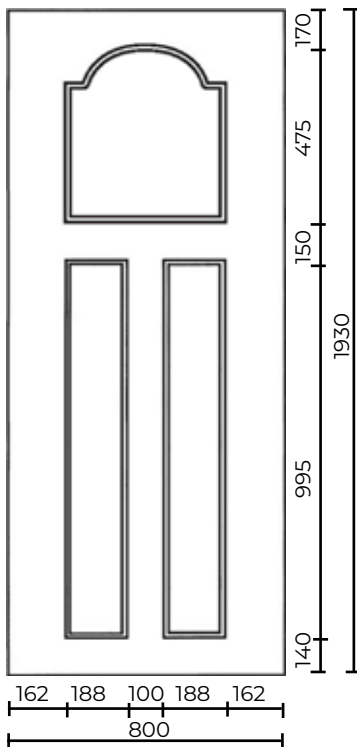

Minimum Cut Size
526mm x 1670mm

Harewood Solid
Harewood One

Highgrove Door Panels

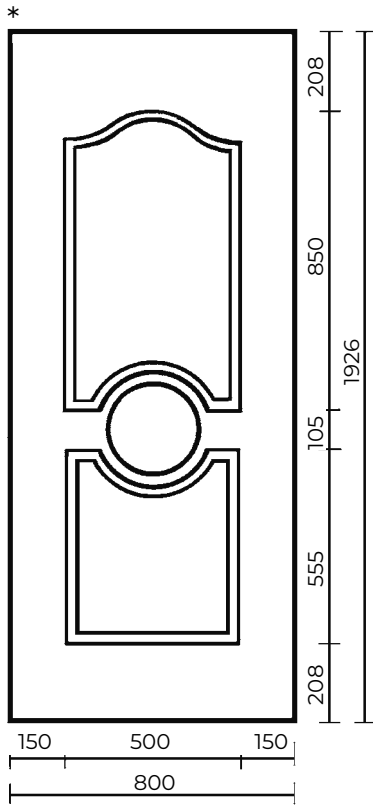

Minimum Cut Size
550mm x 1550mm

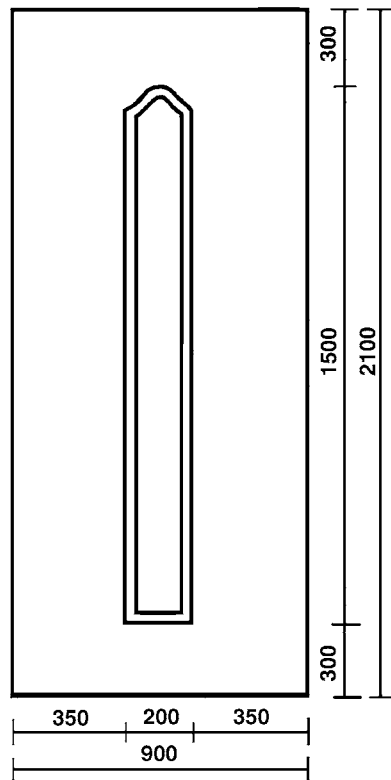

Minimum Cut Size
250mm x 1550mm

Highgrove Solid
Highgrove One
Highgrove Two
Highgrove Solid Side
Highgrove One Side

*Available in Euro Size (900 x 2100)

Kensington Door Panels

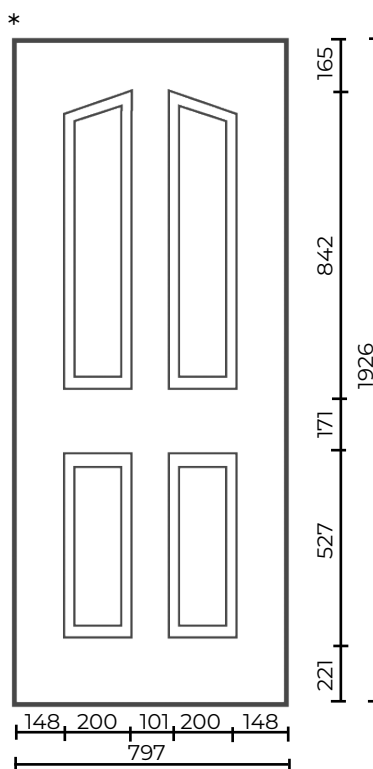

Minimum Cut Size
550mm x 1590mm

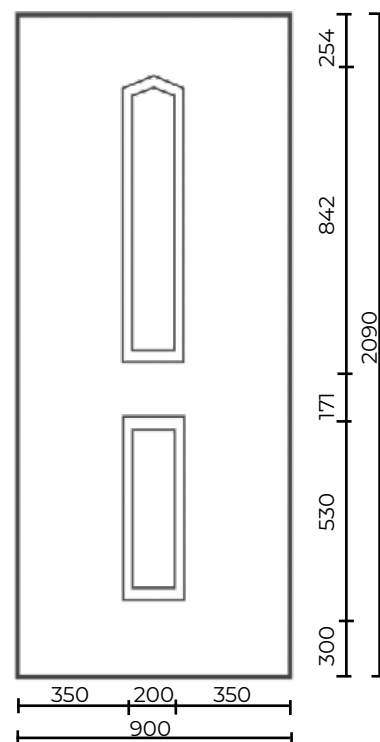

Minimum Cut Size
250mm x 1590mm

Kensington Solid
Kensington Two
Kensington Four
Kensington Solid Side
Kensington One Side
Kensington Two Side

Available inverted except Sides

*Available in Euro Size (900 x 2100)

Lyon Door Panels

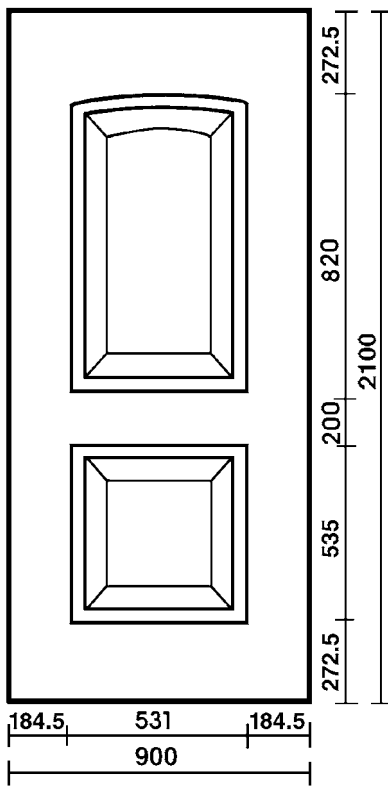

Minimum Cut Size
581mm x 1605mm

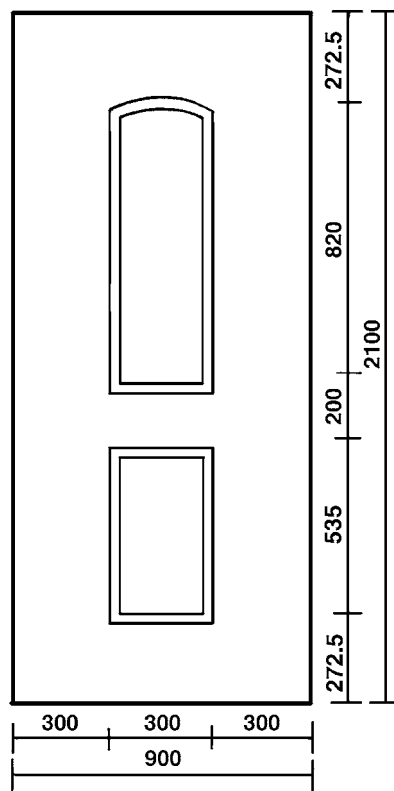

Minimum Cut Size
350mm x 1605mm

Lyon Solid
Lyon One
Lyon Solid Side
Lyon One Side

Madrid Door Panels

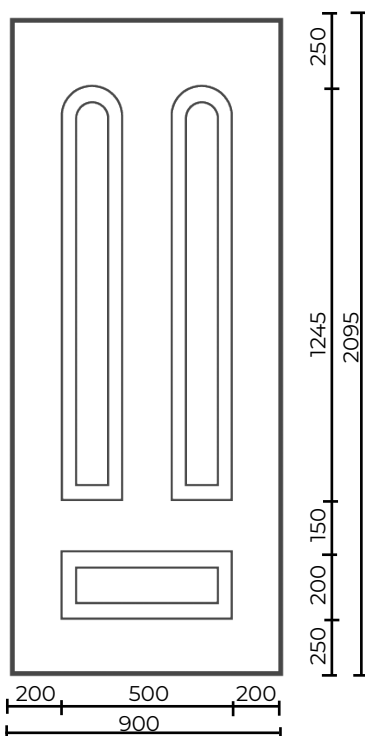

Minimum Cut Size
550mm x 1647mm

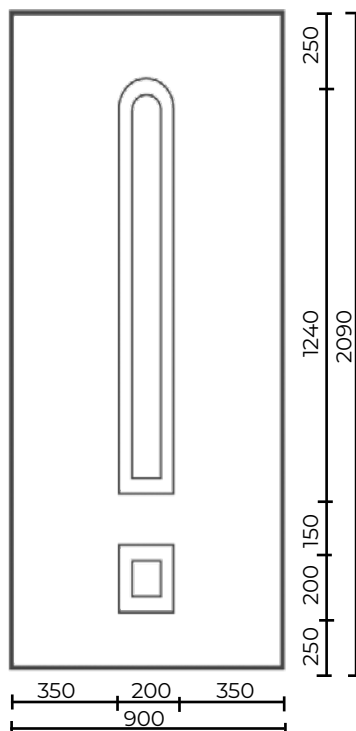

Minimum Cut Size
250mm x 1640mm

Madrid Solid
Madrid Two
Madrid Solid Side
Madrid One Side

Malaga Door Panels

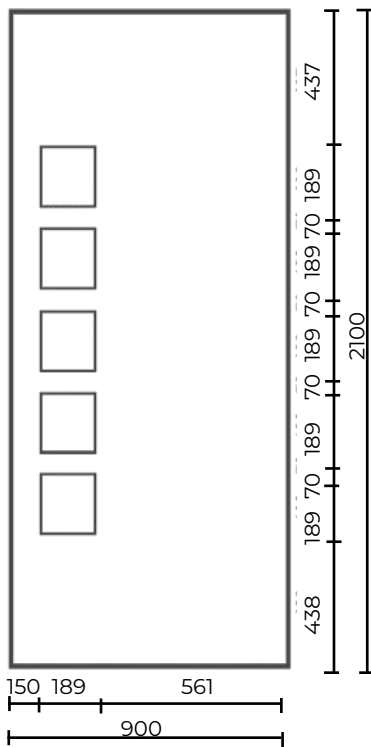

Malaga Solid
Malaga Five

Please Note - One piece sealed glass unit not individual pieces

Minimum Cut Size
239mm x 1275mm

Milan Door Panels

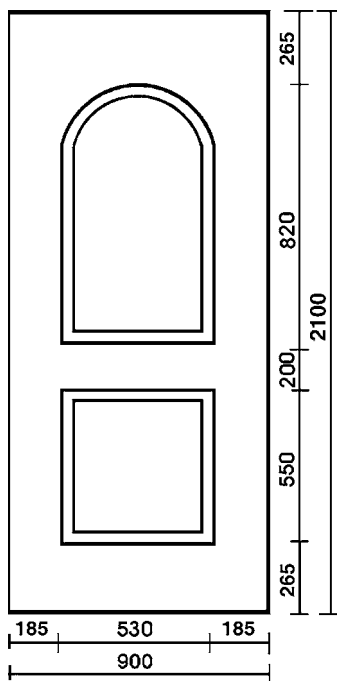

Minimum Cut Size
580mm x 1620mm

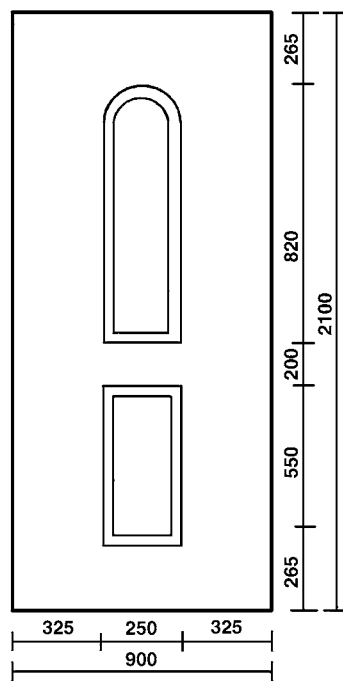

Minimum Cut Size
300mm x 1620mm

Milan Solid
Milan One
Milan Solid Side
Milan One Side

Modern Door Panels

5101

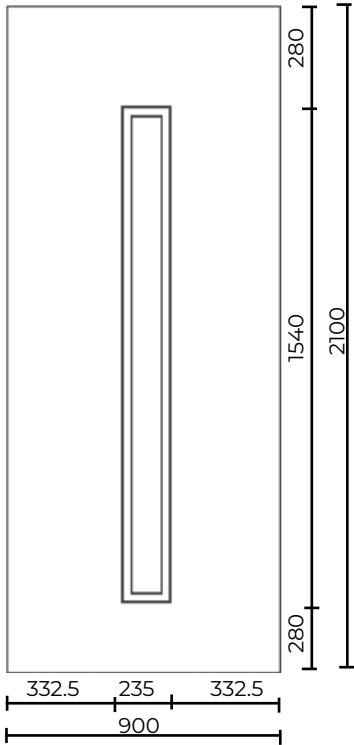

Minimum Cut Size
285mm x 1590mm

5123

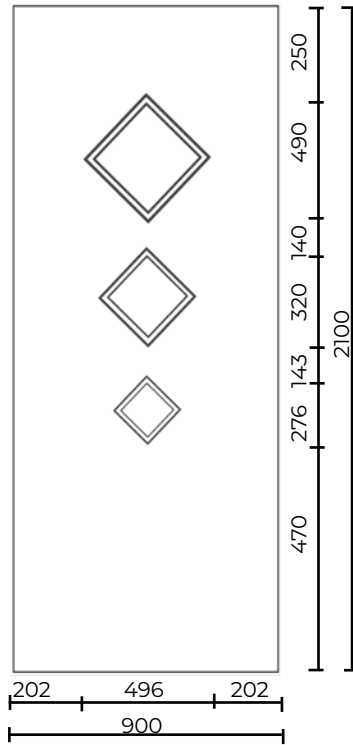

Minimum Cut Size
546mm x 1424mm

5082

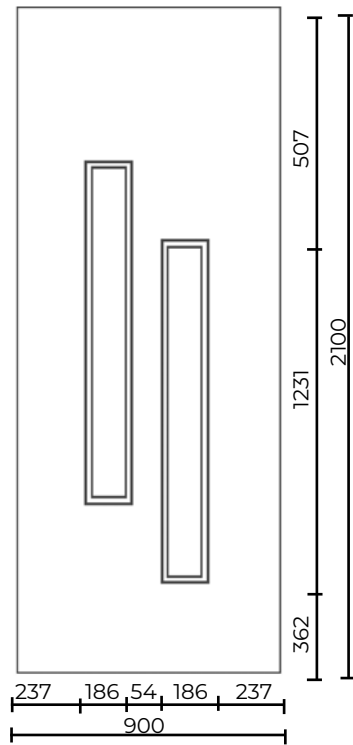

Minimum Cut Size
476mm x 1426mm

5113

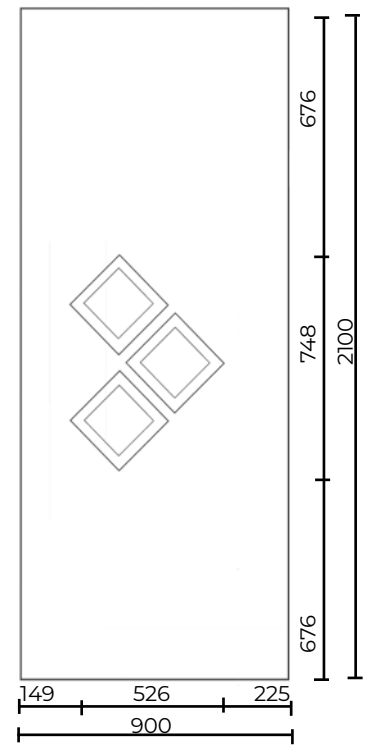

Minimum Cut Size
576mm x 798mm

Modern Door Panels

5013

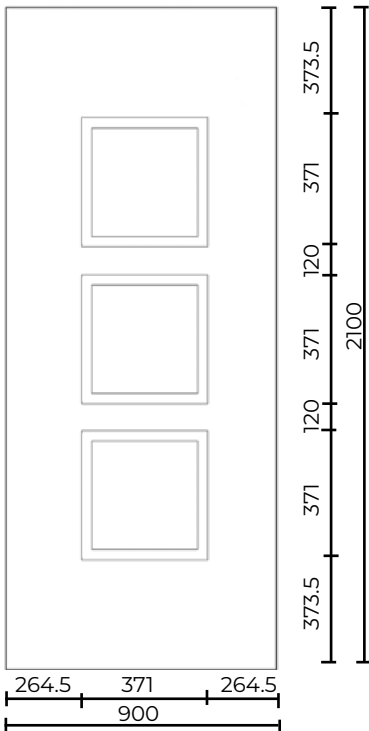

Minimum Cut Size
421mm x 1403mm

5034

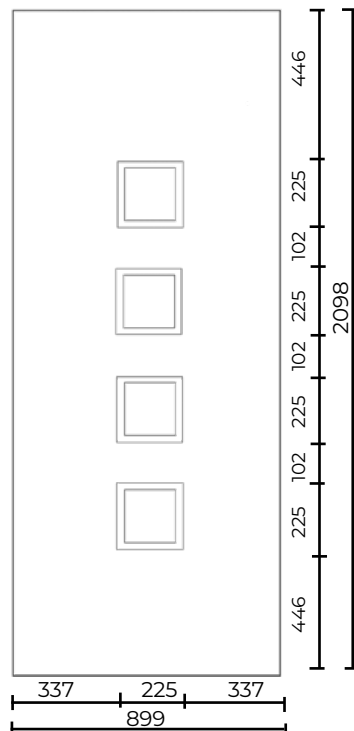

Minimum Cut Size
276mm x 1254mm

5051

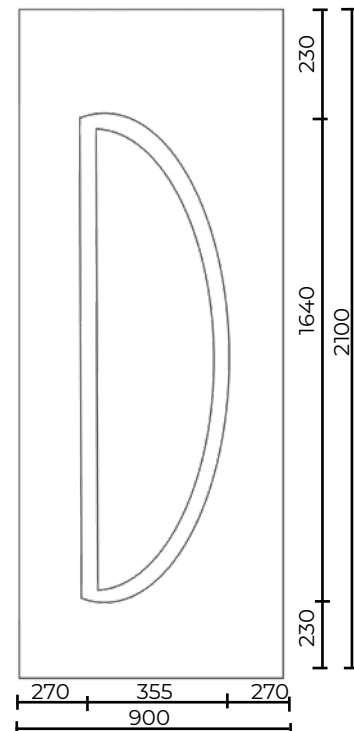

Minimum Cut Size
405mm x 1690mm

5162

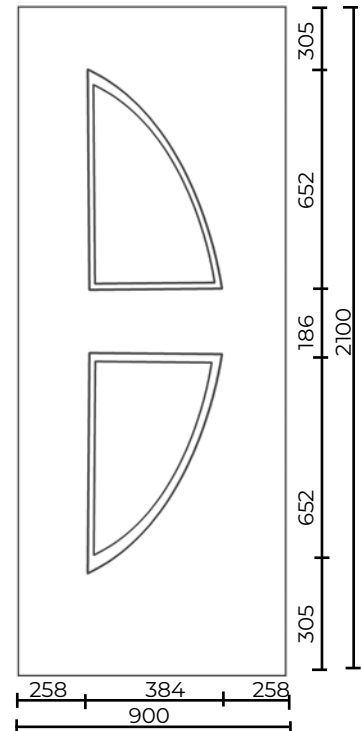

Minimum Cut Size
434mm x 1540mm

Modern Door Panels

5071

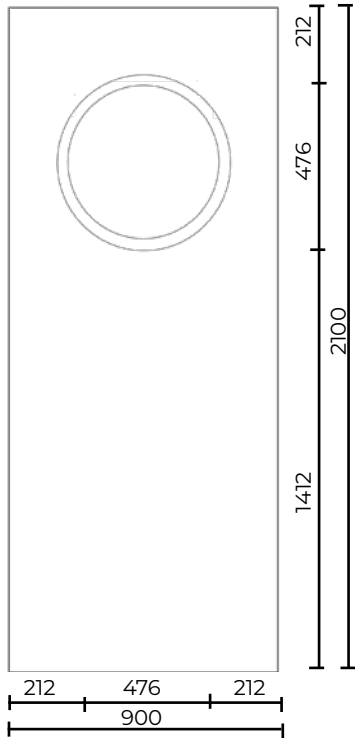

Minimum Cut Size
526mm x 526mm

5131

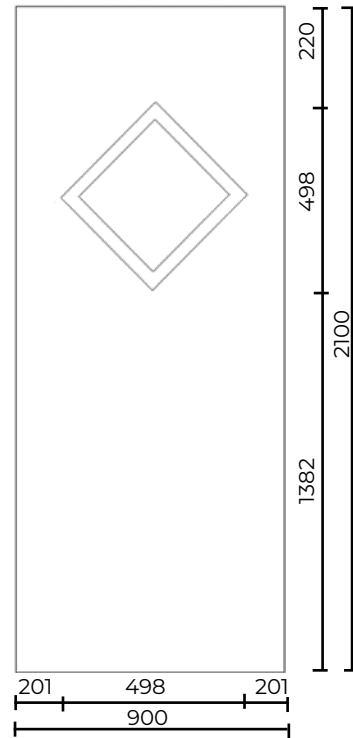

Minimum Cut Size
548mm x 548mm

5141

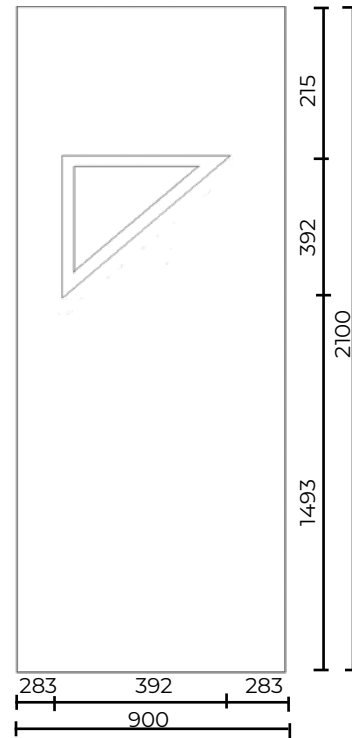

Minimum Cut Size
442mm x 442mm

5171

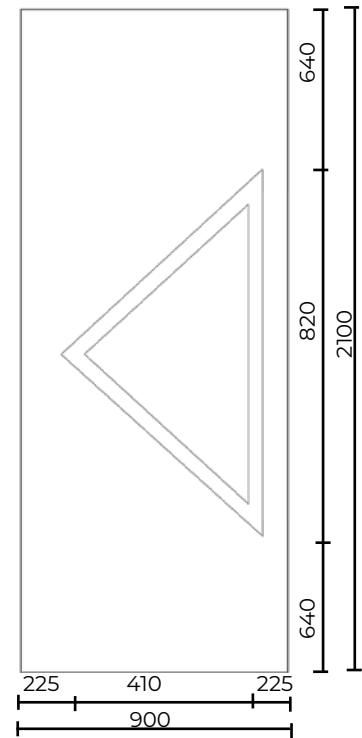

Minimum Cut Size
460mm x 870mm

Please note - Modern Panels Are Not Available Without Trims

Munich Door Panels

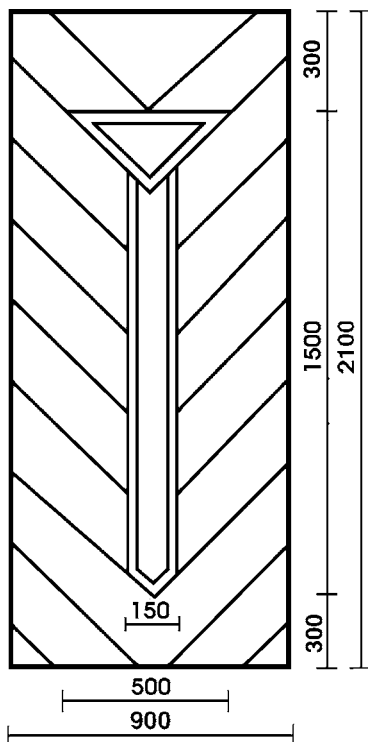

Minimum Cut Size
550mm x 1550mm

Munich Solid
Munich One
Munich Two

Oval Door Panels

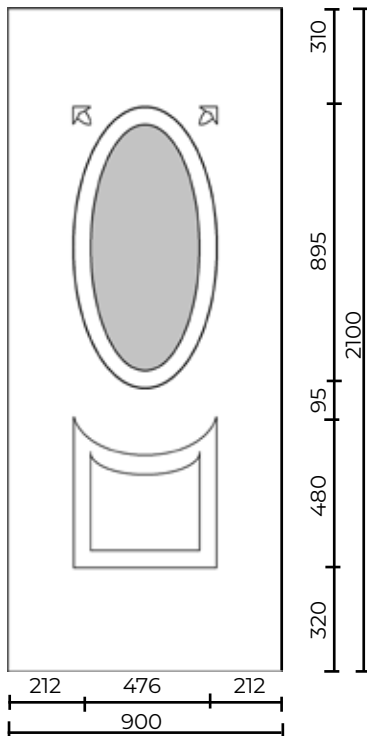

Minimum Cut Size
526mm x 1510mm

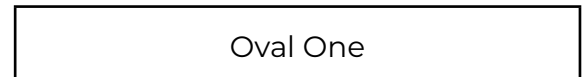

Oxford Door Panels

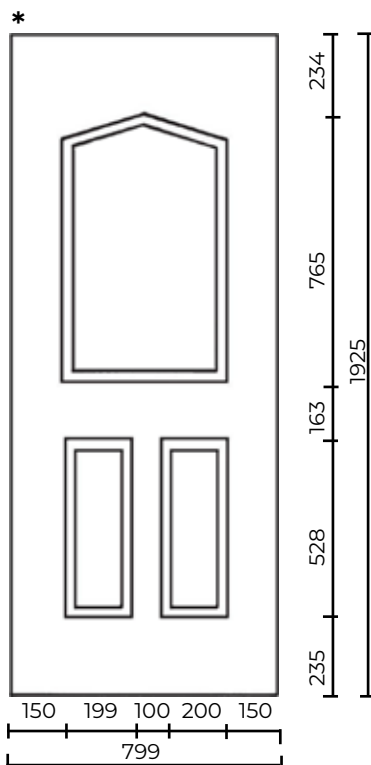

Minimum Cut Size
550mm x 1510mm

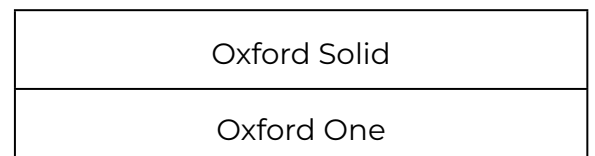

*Available in Euro Size (900 x 2100)

Reims Door Panels

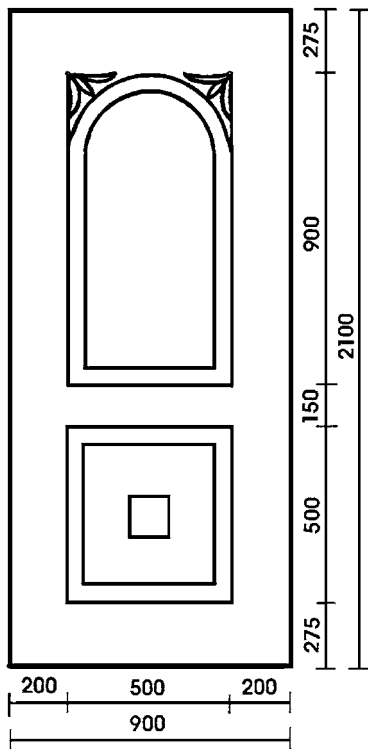

Minimum Cut Size
550mm x 1600mm

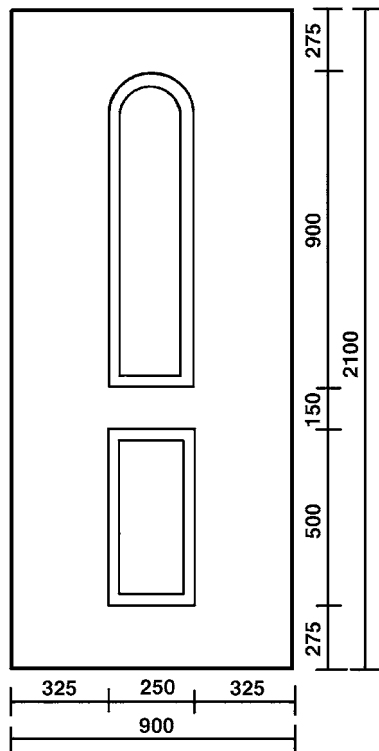

Minimum Cut Size
300mm x 1600mm

Reims Solid
Reims One
Reims Solid Side
Reims One Side

Richmond Door Panels

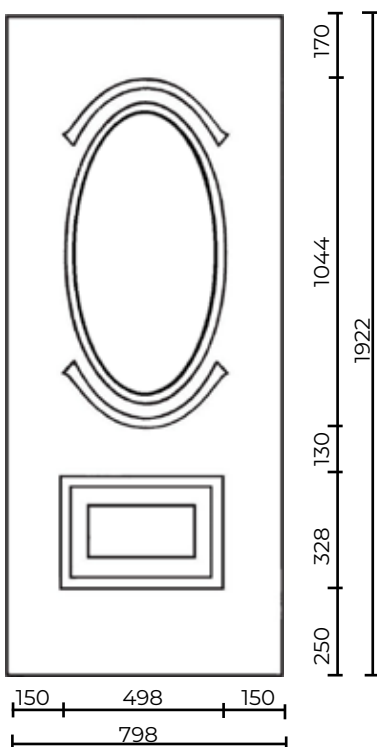

Minimum Cut Size
550mm x 1555mm

Richmond Solid
Richmond One

Rockingham Door Panels

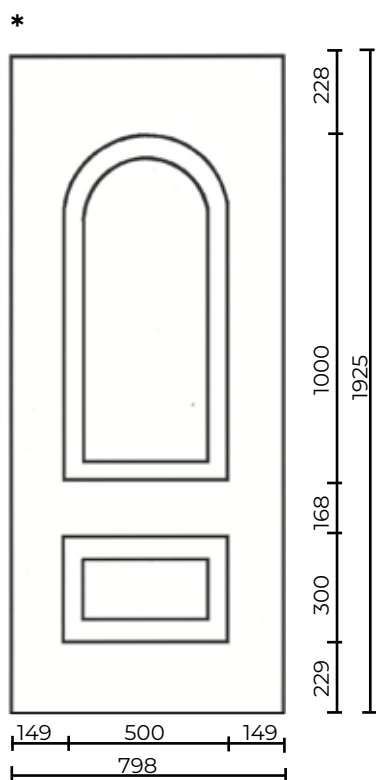

Minimum Cut Size
550mm x 1520mm

Rockingham Solid
Rockingham One

*Available in Euro Size (900 x 2100)

Rome Door Panels

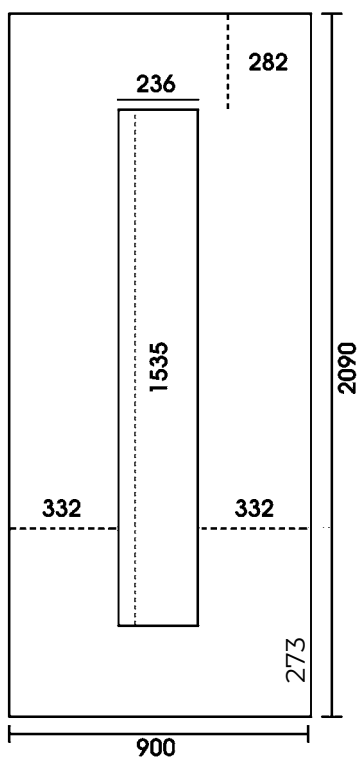

Minimum Cut Size
286mm x 1585mm

Rome Solid
Rome One

Please note - Minimum height to have a letter box - 1700mm

Sandringham Door Panels

*

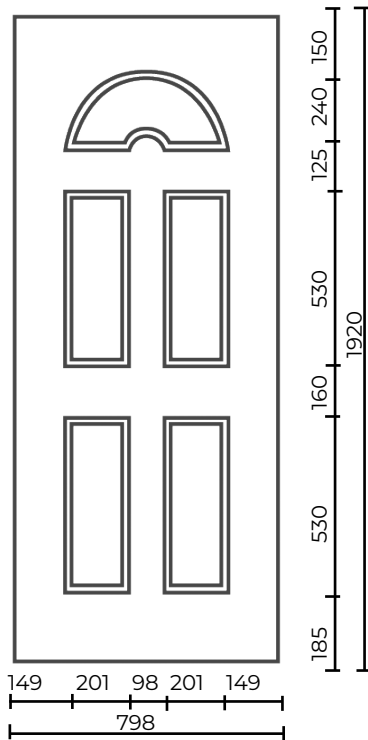

Minimum Cut Size
550mm x 1635mm

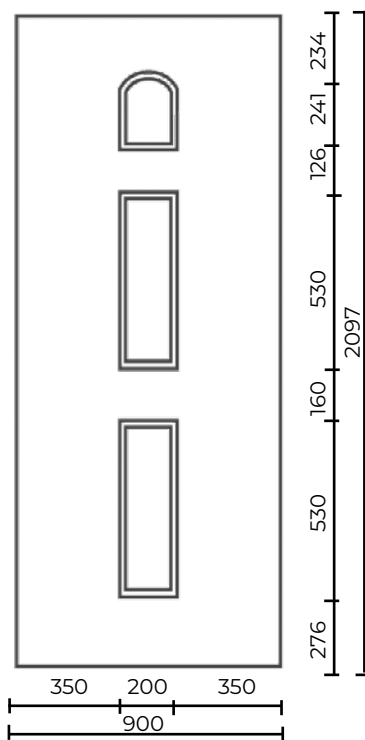

Minimum Cut Size
250mm x 1635mm

Sandringham Solid
Sandringham One
Sandringham Three
Sandringham Five
Sandringham Solid Side
Sandringham One Side
Sandringham Two Side
Sandringham Three Side

*Available in Euro Size (900 x 2100)

Seville Door Panels

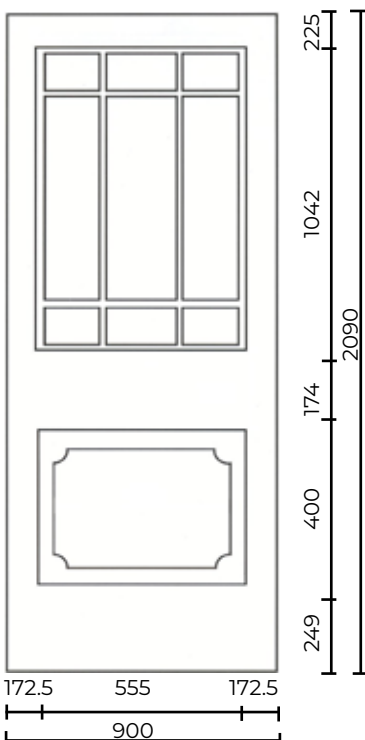

Minimum Cut Size
605mm x 1666mm

Seville Solid
Seville One

Please Note - This panel must be reinforced
- One piece sealed glass unit not individual pieces

Sofia Door Panels

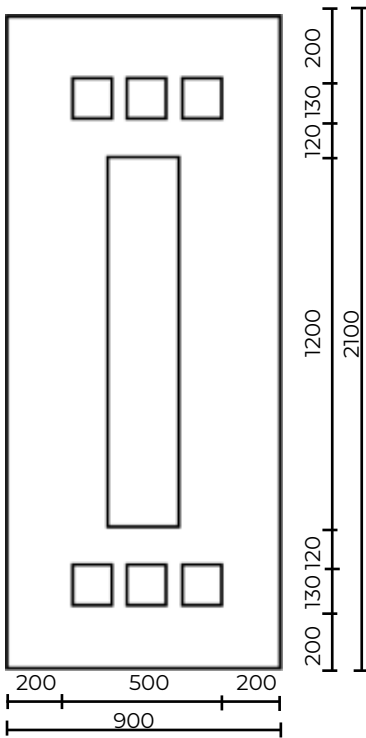

Minimum Cut Size
550mm x 1750mm

Sofia Solid
Sofia One

Turin Door Panels

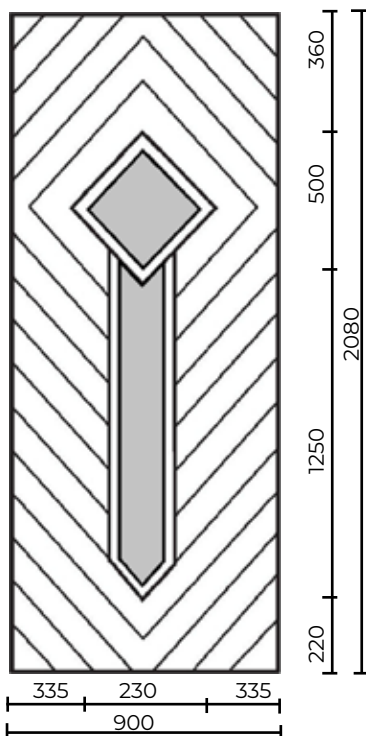

Minimum Cut Size
550mm x 1670mm

Turin Solid
Turin One
Turin Two

Versailles Door Panels

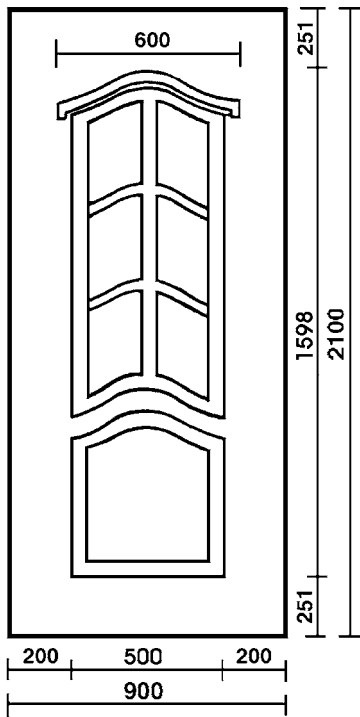

Minimum Cut Size
650mm x 1648mm

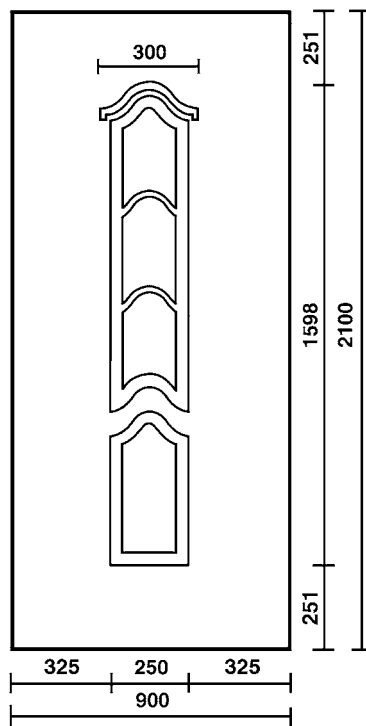

Minimum Cut Size
350mm x 1648mm

Versailles Solid
Versailles One
Versailles Solid Side
Versailles One Side

Vienna Door Panels

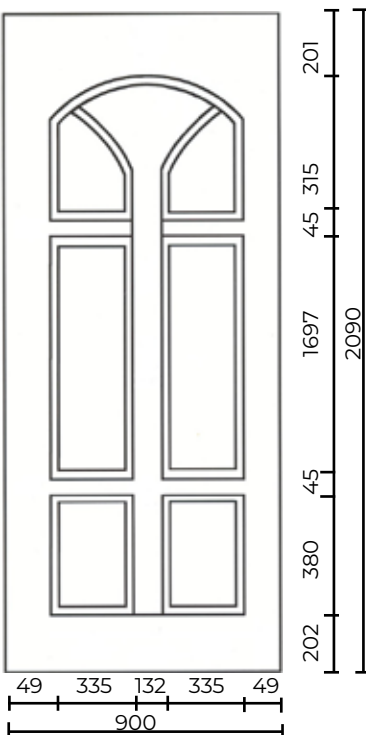

Minimum Cut Size
650mm x 1747mm

Vienna Solid
Vienna Two

Please note - Minimum height available with a letterplate 1825mm

Windsor Door Panels

*

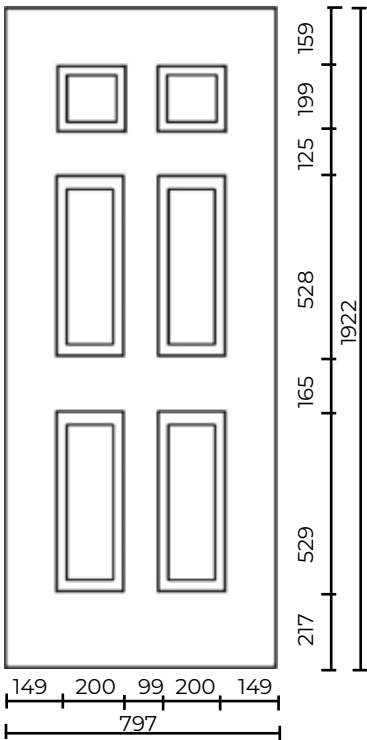

Minimum Cut Size
550mm x 1590mm

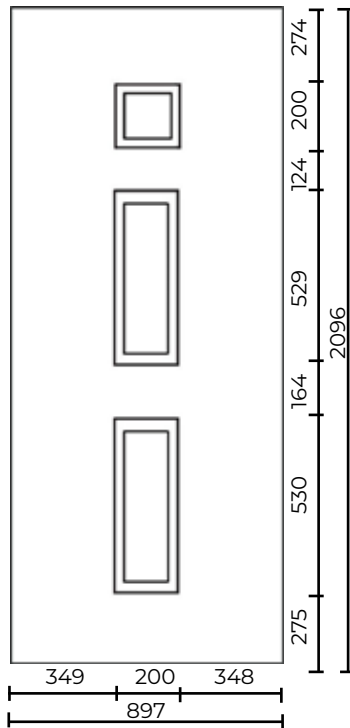

Minimum Cut Size
250mm x 1590mm

Windsor Solid
Windsor Two
Windsor Four
Windsor Six
Windsor Solid Side
Windsor One Side
Windsor Two Side
Windsor Three Side

Available inverted except Sides

*Available in Euro Size (900 x 2100)

Quarter Panels

Elizabethan

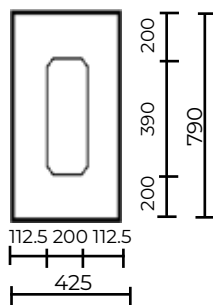

Minimum Cut Size
250mm x 440mm

Winchester

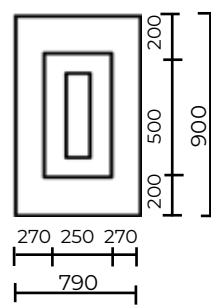

Minimum Cut Size
300mm x 550mm

Manor

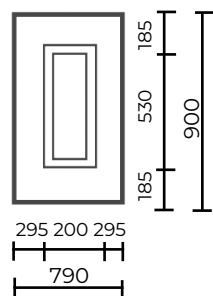

Minimum Cut Size
250mm x 580mm

Cathedral

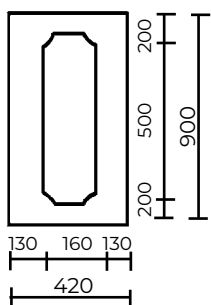

Minimum Cut Size
210mm x 550mm

Conservatory Panels

Hanover

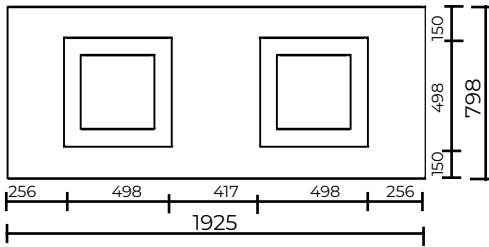

Minimum Cut Size
1470mm x 550mm

Hanover Triple

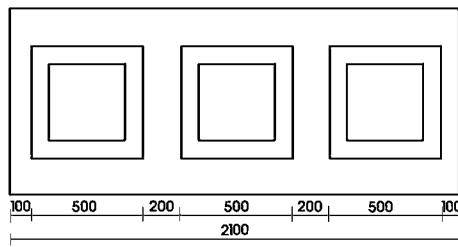

Minimum Cut Size
1950mm x 550mm
Also available with
460mm mould width

Winchester

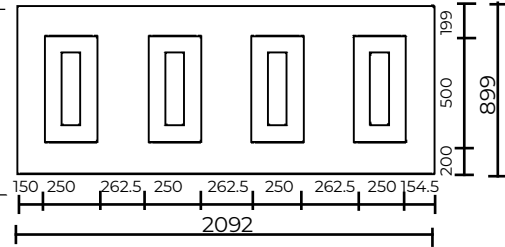

Minimum Cut Size
1845mm x 550mm

Elizabethan

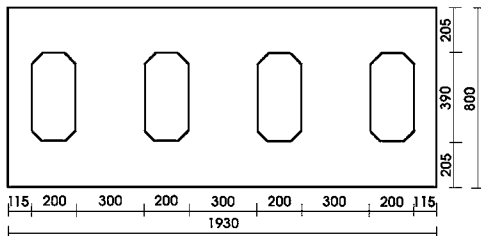

Minimum Cut Size
1750mm x 440mm

Manor

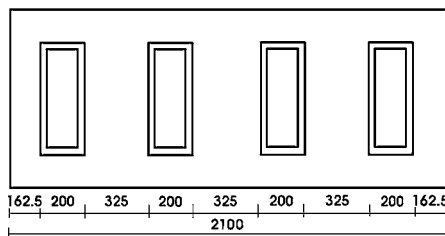

Minimum Cut Size
1825mm x 580mm

Manor Triple

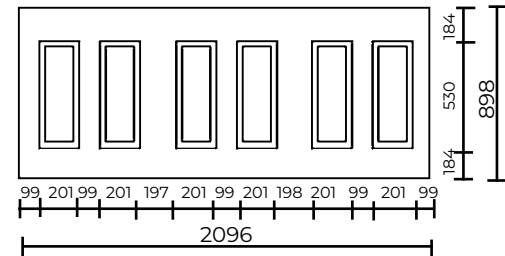

Minimum Cut Size
1950mm x 580mm
Also available with
460mm mould width

Westminster

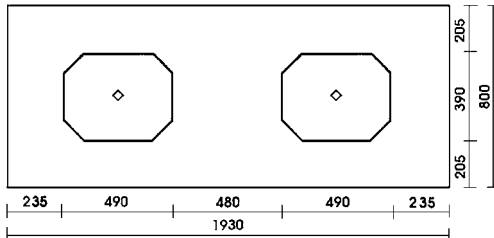

Minimum Cut Size
1510mm x 440mm

Abbey

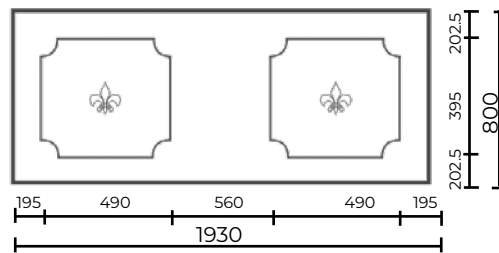

Minimum Cut Size
1590mm x 445mm

Buckingham

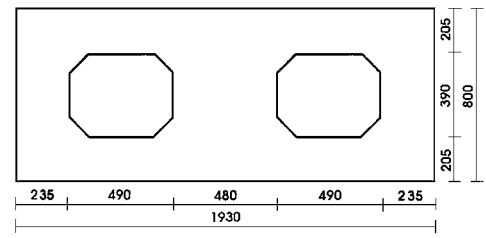

Minimum Cut Size
1510mm x 440mm

Cathedral

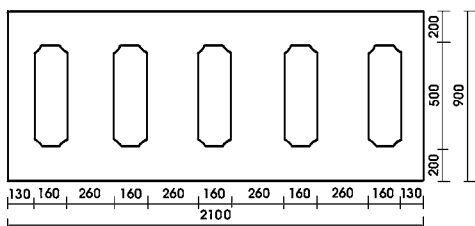

Minimum Cut Size
1890mm x 550mm

Please note - When having
Woodgrain/Colourgrain
the grain runs horizontally
not vertically. These will be
supplied as standard unless
clearly specified otherwise.

Conservatory Panels Continued...

Manor Full

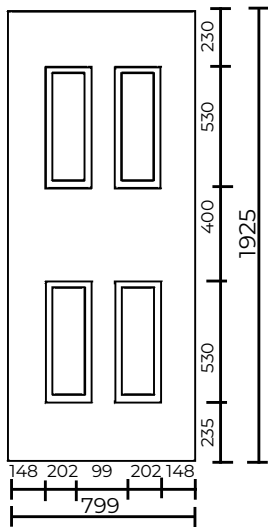

Shiplap

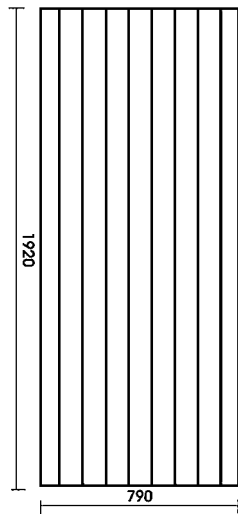

Declap

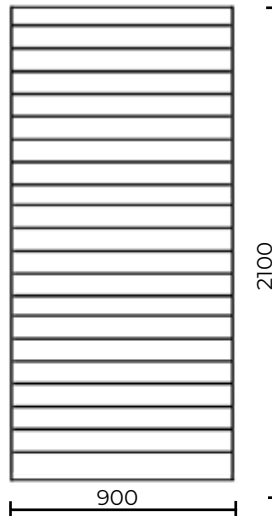

Herringbone

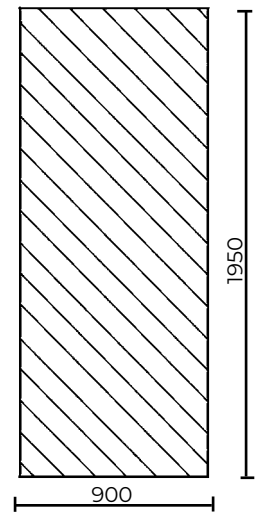

Minimum Cut Size
550mm x 1510

Available Inverted

Also available in Euro size
900mm x 2100mm

**Please Note - the
moulding is slightly
deeper in
Euro sized panels**
Groove size 80mm/10mm

Only available in Euro size
900mm x 2100mm

Groove size 77mm/14mm

Half Panels

Abbey

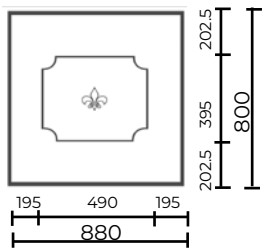

Minimum Cut Size
540mm x 445mm

Buckingham

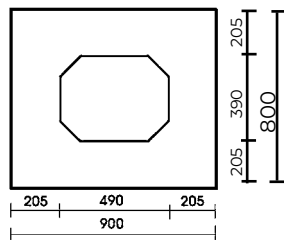

Minimum Cut Size
540mm x 440mm

Manor

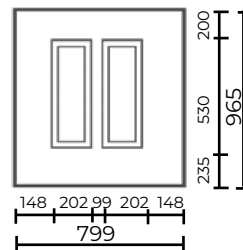

Minimum Cut Size
550mm x 580mm

460mm halves are on a triple half sheet

Manor Inverted

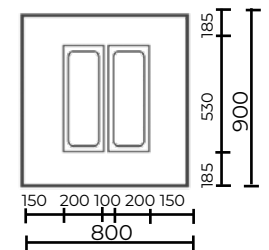

Minimum Cut Size
550mm x 580mm

Hanover

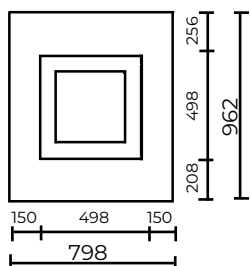

Minimum Cut Size
550mm x 550mm

Hanover Slimline

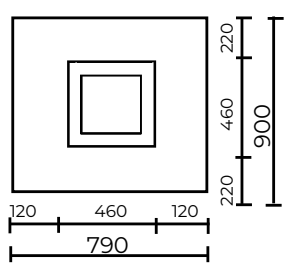

Minimum Cut Size
510mm x 510mm

460mm halves are on a triple half sheet

Westminster

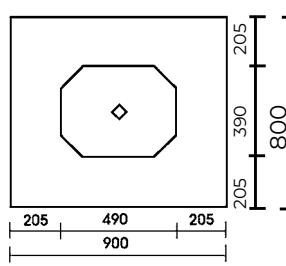

Minimum Cut Size
540mm x 440mm

**Please note - on Manor and
Manor inverted half panels
the grain runs vertically not
horizontally. These will be
supplied as standard unless
clearly specified otherwise.**

460mm halves are on a triple half sheet

Flat Panels

Size	Available Woodgrain	Available Colourgrain
1500mm x 3000mm	No	No
900mm x 2100mm	Yes	Yes
900mm x 1040mm	Yes	No
440mm x 2100mm	Yes	No
440mm x 1040mm	Yes	No

Please Note - On grained flat panels the grain runs vertically
Woodgrains and Colourgrains are sold with 4mm MDF reinforcing as standard

Woodgrain Door Panels

All woodgrain and colourgrain panels feature 'heat-reflective' technology - an advanced technical process designed to significantly reduce the effect of UV light on darker surfaces thereby improving stability.

Hurst Doors have also introduced a system of venting the moulds which allows the expanding air to escape, thus reducing the incidence of de-lamination and cracking.

An adhesive is also used which has a higher co-efficient of expansion, greater elasticity properties and better adhesion qualities. Due to the nature of this product we strongly recommend that woodgrain door panels are not exposed to strong sunlight.

MDF and Thickness Options

	CM1 - Full Poly	CM3 - 4mm MDF	CM16 - Solid MDF	CM17 - 8mm MDF	CM18 - 12mm MDF	CM20 - Poly/ Ali/ MDF/ Poly	CM21 - MDF/ MDF/ Ali
3000mm x 1500mm	20mm 24mm 28mm	20mm 24mm 28mm		24mm 28mm	28mm	20mm 24mm 28mm	28mm
900mm x 2100mm	20mm 24mm 28mm 18mm	20mm 24mm 28mm 19mm	20mm 24mm 28mm	20mm 24mm 28mm	24mm 28mm	20mm 24mm 28mm	28mm
900mm x 1040mm	24mm 28mm	24mm 28mm	24mm 28mm	24mm 28mm	24mm 28mm	24mm 28mm	
440mm x 2100mm	24mm 28mm	24mm 28mm	24mm 28mm	24mm 28mm	24mm 28mm	24mm 28mm	
440mm x 1040mm	24mm 28mm	24mm 28mm	24mm 28mm	24mm 28mm	24mm 28mm	24mm 28mm	

Ali is 0.6mm

Ancillaries

	Gold	Chrome	Black	Satin Chrome	White
Letterbox	Yes	Yes	Yes	Yes	Yes
Urn Knocker	Yes	Yes	Yes	Yes	Yes
Slimline Urn Knocker	Yes	Yes	Yes		Yes
Urn Knocker with Spyhole	Yes	Yes	Yes	Yes	Yes
Slimline Urn Knocker with Spyhole	Yes	Yes	Yes		Yes
Spyhole	Yes	Yes	Yes	Yes	Yes
Lion's Head Knocker	Yes		Yes		
Numerals	Yes	Yes	Yes	Yes	

Backing Glass Options

Platinum units must be reinforced

Clear	Chinchilla
Stippolyte	Florielle
Autumn	K Glass*
Everglade	Laminate*
Flemish	Mayflower
Sycamore	Oak
Contour	Pelerine
Cotswold	Sandblasted*/Satin*
Minster	Taffeta
Arctic	Warwick*
Chantilly	Satin*
Charcoal Sticks	Bronze Anti Sun*

* Surcharge applies

Colourgrain/ Woodgrain Options

Colourgrain	RAL	Available on Moulded Panels	Available on Flat Panels
Red	3011	Yes	Yes
Blue	5011	Yes	Yes
Chartwell Green		Yes	Yes
Green	6009	Yes	Yes
Silver Grey	7001	Yes	Yes
Slate Grey	7015	Yes	Yes
Anthracite Grey Grained	7016	Yes	Yes
Agate Grey	7038	No	Yes
Black/Brown	8022	Yes	Yes
Beige	9001	Yes	Yes
Cream/White	9010	Yes	Yes
White	9152	No	Yes
Irish Oak		Yes	Yes
An Teak		Yes	Yes

Woodgrain	Available on Moulded Panels	Available on Flat Panels
Rosewood	Yes	Yes
Mahogany - 013	Yes	Yes
Mahogany - 021	Yes	Yes
Golden Oak	Yes	Yes

Profile Options

Profile Name	White Code	Mahogany Code
Advance/Elite 70	626	
Decurnick	830	021
Decurnick Zendow	626	
Duraflex	625	013
Duraflex Warm	626	
Duraflex Bright	993	
Eurocell	830	013
Kommerling	626	021
Legend 70	C154	013
Linier	830	013
Profile 22	626	013
Rehau	626	021
Selecta	626	013
Spectus	2152	013
Synseal Synergy/Sheild	689	013
Synseal Legend	C154	013
System 10	626	013
Veka	2152	021
WHS Halo	626	021
Hurst Standard	623	

Stock Backing Glass

PANELS	CLEAR	AUTUMN	CONTOUR	COTSWOLD	MINSTER	STIPPOLYTE	ARCTIC	CHANTILLY	CHARCOAL	CHINCHILLA	EVERGLADE	FLEMSIH	FLORIELLE	K GLASS	LAMINATE	MAYFLOWER	OAK	PELERINE	S/BLAST	SYCAMORE	TAFFETA	WARWICK	
ALNWICK 1																							
ALTHORPE 1 INVERTED																							
BALMORAL 1																							
BALMORAL 1 CLASSIC																							
BALMORAL 1 CLASSIC SIDE																							
BALMORAL SLIMLINE 1																							
BALMORAL 2																							
BLENHEIM 1																							
BRUGES 1 SIDE																							
BRUGES 4 SIDE																							
CAMBRIDGE 1																							
CANTERBURY 1																							
CANTERBURY 1 SIDE																							
CANTON 1																							
CHATSWORTH 1																							
HAMBURG 1																							
KENSINGTON 1 SIDE																							
KENSINGTON 2																							
KENSINGTON 2 INVERTED																							
KENSINGTON 2 SIDE																							
KENSINGTON 4																							
LYON 1																							
MADRID 1 SIDE																							
MADRID 2																							
MALAGA 5																							
OVAL 1																							
OXFORD 1																							
REIMS 1 SIDE																							
RICHMOND 1																							
ROCKINGHAM 1																							
ROME 1																							
SANDRINGHAM 1																							
SANDRINGHAM 1 SIDE																							
SANDRINGHAM 2 SIDE																							
SANDRINGHAM 3																							
SANDRINGHAM 3 SIDE																							
SANDRINGHAM 5																							
SEVILLE 1																							
TURIN 1																							
WINDSOR 2 INVERTED																							
WINDSOR 2 SIDE INVERTED																							
WINDSOR 3 SIDE INVERTED																							
WINDSOR 4 INVERTED																							
WINDSOR 6 INVERTED																							
WINDSOR 1 SIDE																							
WINDSOR 2																							
WINDSOR 2 SIDE																							
WINDSOR 3 SIDE																							
WINDSOR 4																							
WINDSOR 6																							
5013 MODERN PANEL																							
5034 MODERN PANEL																							
5042 MODERN PANEL																							
5065 MODERN PANEL																							
5071 MODERN PANEL																							
5082 MODERN PANEL																							
5101 MODERN PANEL																							
5113 MODERN PANEL																							
5123 MODERN PANEL																							
5131 MODERN PANEL																							

Key

	Stock glass
	Non-stock glass (generally available in standard lead times,
	Unavailable glass

Class Sizes

Panel Type	Projection	C/B	Actual size mm		Sightline mm		
			Width	Height	Width	Height	
Acacia One Inverted		No	252	584	217	555	
Alnwick One		Yes	390	693	350	655	
Alnwick One Inverted		Yes	397	702	370	673	
Althorpe One Inverted		No	440	830	410	800	
Althorpe Oval One Inverted		No	325	585	310	570	
Balmoral One - small aperture		Yes	315	705	285	675	Top
Balmoral Two		Yes	315	315	285	285	Bottom
Balmoral One Classic - large aperture		Yes	445	840	410	805	Top
Balmoral Two Classic		Yes	445	445	410	410	Bottom
Balmoral Slim - Wendland 1		Yes	360	640	330	610	Top
Balmoral Slim - Wendland 2		Yes	360	360	325	325	Bottom
Balmoral One Classic Side		Yes	185	845	150	805	Top
Balmoral Two Classic Side		Yes	185	440	150	400	Bottom
Blenheim		No	420	420	390	390	
Cambridge Georgian Bow Fronted	33mm	N/A	500	770	100	190	1 sheet glass
Canterbury One		Y + Arch	437	1180	400	1135	
Canterbury One Side		Not advised	130	1175	95	1140	
Canton One		Yes	295	295	270	270	
Chatsworth		Yes	290	375	260	338	
Cheltenham		Yes	385	895	345	840	
Hamburg			295	295	265	265	
Harewood One		No	445	445	395	390	
Highgrove One		No	405	760	365	625	Top * See drawings tab
Highgrove Two		No	403	466	365	420	Bottom * See drawings tab
Highgrove One Side		No	105	1385	65	1134	
Kensington Two		Yes	135	770	110	740/710	
Kensington Two Inverted		No	140	765	115	730/705	
Kensington Four		Yes	135	465	110	438	
Kensington One Side		Not advised	140	790	112	755	Top
Kensington Two Side		Not advised	135	465	110	438	Bottom
Madrid Two		Not advised	130	1175	95	1140	
Madrid One Side		Not advised	130	1175	95	1140	
Malaga Five		No	130	1175	95	90	x 5
Oxford One		Yes	445	707	405	610	
Richmond One		No	421	837	370	785	
Rockingham One		Yes	375	885	345	840	
Rome One		No	180	1485	135	1425	
Sandringham One		Yes	440	178	385	107	
Sandringham Three		Yes	135	465	110	438	x2
Sandringham Five		Yes	135	465	110	438	x4
Sandringham One Side		No	140	700	110	144	Top
Sandringham Two Side		No	135	465	110	438	Bottom
Sandringham Three Side		No	135	465	110	438	Bottom
Seville		N/A	502	985			1 sheet glass (usually)
Sofia One		No	200	1160	155	1110	
Turin One			295	295	340	340	
Turin Two			162	1039	120	910	
Versailles			420	975	165	230	
Versailles Side			175	925	135	245	
Windsor Two		Not advised	140	140	110	110	Top
Windsor Four		Not advised	135	465	110	438	Bottom
Windsor Six		Not advised	135	465	110	438	Bottom
Windsor One Side		Not advised	140	140	110	110	Top
Windsor Two Side		Not advised	135	465	110	438	Bottom
Windsor Three Side		Not advised	135	465	110	438	Bottom
5034			170	170	144	144	
5101			180	1485	155	1460	
5013			315	315	290	290	
5071			420	420	390	390	
5131			295	295	266	266	
5141			350	487	304	430	
5123 top			295	295	270	270	
5123 middle			175	175	144	144	
5123 bottom			140	140	114	114	
5113			175	175	144	144	
5051			300	1450	275	1420	
5082			130	1175	104	1150	
5162			345	590	295	530	



Enquiries:

Call 01482 790790

info@hurstdoors.co.uk

  **@HurstDoors**

Visit hurstdoors.co.uk

Hurst Doors,
Unit One,
Kingston International Business Park,
Somerden Road, Hedon Road,
Hull HU9 5PE

Designs represented in this publication are protected by copyright owned by or licensed exclusively by Hurst Doors (Hurst Plastics Limited). Product Descriptions, Colours and Unique Features: Every effort is made to ensure that the products we supply correspond as closely as possible to the examples shown in the brochure. Due to a continuous development programme, Hurst Doors (Hurst Plastics Limited) reserve the right to alter specifications without prior notice. All specifications are correct at the time of going to print. E. & O. E.